

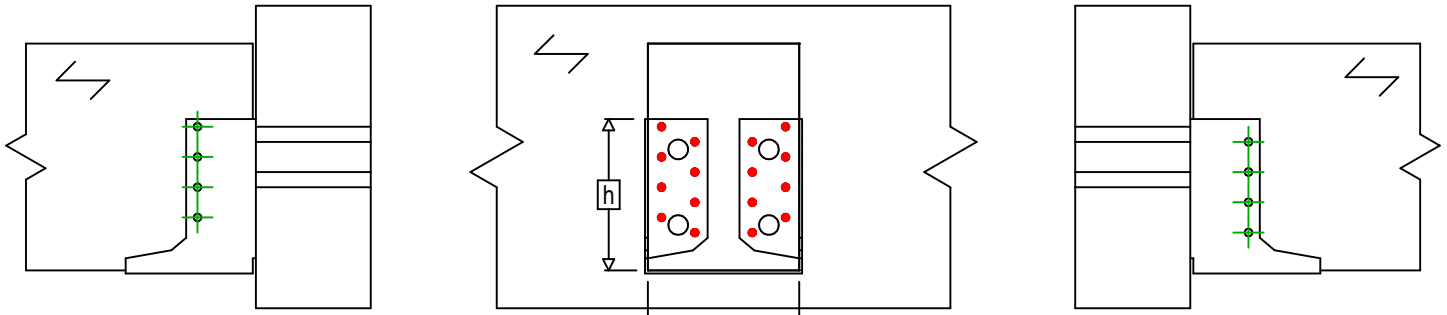

Référence =	BSIN300	
Fixations =	Bois sur bois	Solive sur poutre
Type de fixation =	Clouage total	

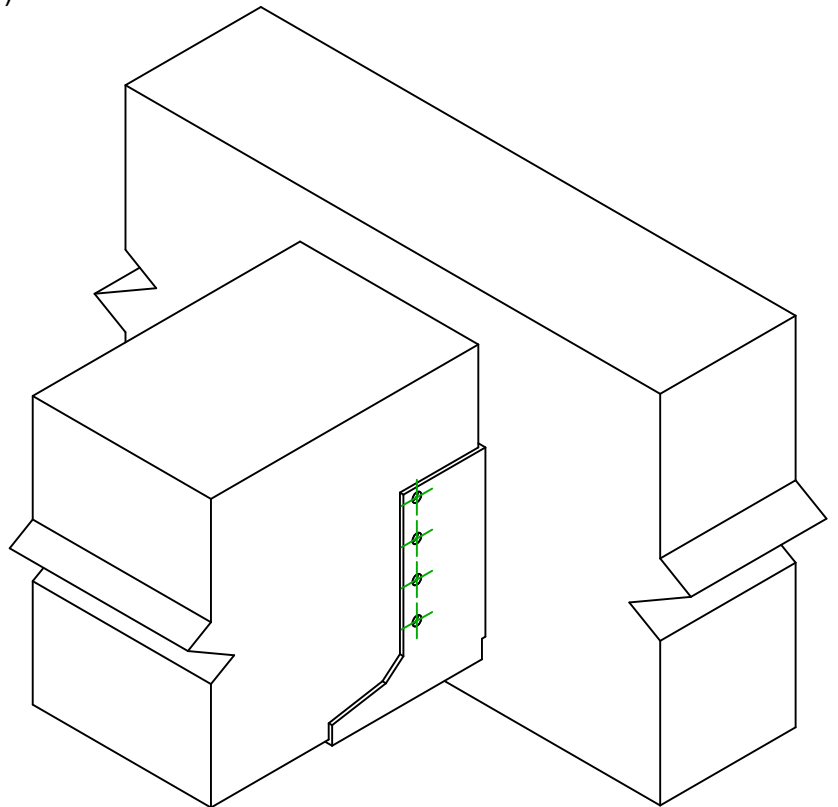

$$h = (300 - L) / 2$$



Fixation(s)	Symbole	Fixations	Fixations		Qté	
	Porteur		CNA	CNA4.0X35 / CNA4.0X50		16
	CSA		CSA5.0X35 / CSA5.0X40			
	-		-			
Fixation(s)	Symbole	Fixations	L < 64mm	L > 64mm	Qté	
		CNA	CNA4.0X35	CNA4.0X50		8
		CSA	CSA5.0X35	CSA5.0X40		